

# siegmund

SYSTÈME DE BRIDAGE ET DE SOUDURE



**NEW DESIGN**

**Etabli Siegmund**

à partir de **796 €**

voir page 30

**NEW**

Prix Promo **%**

**Cellule de soudure laser  
2400x2400 mm inclus Table  
de soudure et de bridage**

**8.997 €**

voir page 46

# MONTAGES LÉGERS À LOURDS

Notre System le plus robuste est adapté pour toutes les pièces en partant de pièces légères à très lourdes grâce à la résilience et la rigidité. Les moyens de bridage robustes maintiennent aussi de grosses pièces et empêchent la déformation lors du soudage.

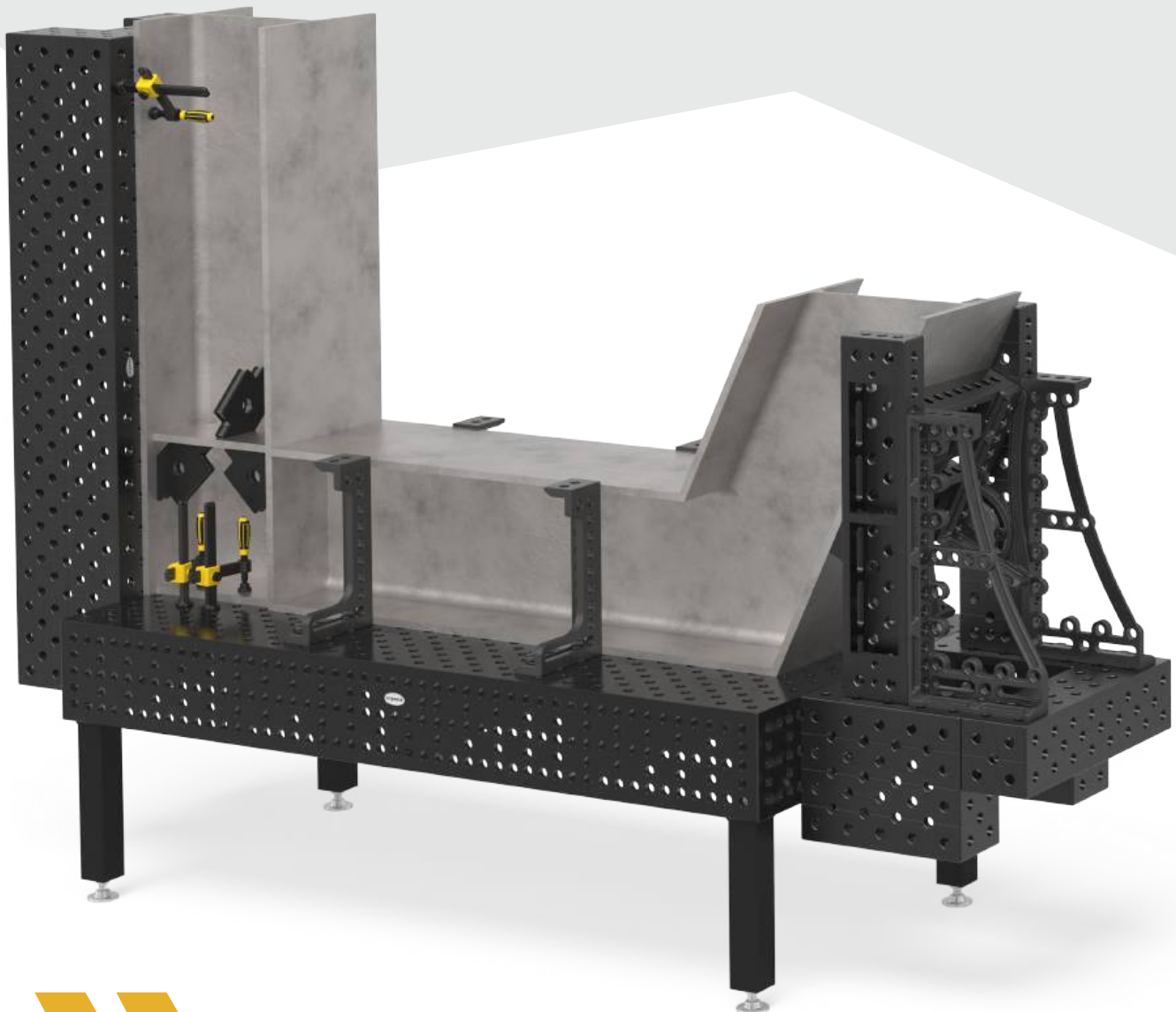

## Charge maxi conseillée jusqu'à 6000 kg

charge maxi par pied standard 2000 kg

charge maxi par pied standard PLUS 3000 kg

# Basic 750

- Acier de qualité S355J2+N
- Épaisseur env. 24,5 – 27 mm
- Alésages Ø 28 mm, Alésages sur le dessus de la table quadrillage 100x100 mm
- Filetage M12 sur 4 côtés tous les 200 mm
- y compris pieds standards



Dimensions de table	Pieds	Poids			Transport / Emballage
1200 x 1200 mm	4	354 kg	<b>1.398 €</b>	4-281015	● 345 €
1500 x 1000 mm	4	370 kg	<b>1.417 €</b>	4-281035	● 345 €
2000 x 1000 mm	4	475 kg	<b>1.820 €</b>	4-281020	● 410 €
2000 x 1200 mm	4	569 kg	<b>2.059 €</b>	4-281060	● 410 €
2400 x 1200 mm	6	697 kg	<b>2.317 €</b>	4-281030	● 429 €
3000 x 1500 mm	6	1043 kg	<b>3.202 €</b>	4-281040	● 488 €



Poids = Table + Palette + Pied standard

Charge statique totale conseillée pour 4 pieds 2000 kg avec une répartition uniforme de la charge. (Données pour pied standard)

Sans nitruration plasma: Pas de protection contre la rouille, les rayures et les projections de soudure. Protection contre l'adhérence des projections de soudure uniquement en vaporisant l'anti-collage.



[www.siegmund.com/  
F-tablebasic75028](http://www.siegmund.com/F-tablebasic75028)

## Pieds de table



	Equipement standard	Réglable en hauteur	Sur roulette avec frein de blocage	Sur roulette réglable en hauteur avec frein de blocage	Ancrage au sol
	161856	4-160877.XX	4-161855.XX	4-160879.XX	4-160874.XX
Charge par pied	1000 kg	1000 kg	200 kg	200 kg	1000 kg
Hauteur des pieds	815 mm	550 – 950 mm	815 mm	600 – 900 mm	815 mm
Réglage fin	50 mm	40 mm	30 mm	30 mm	50 mm
Surcoût par pied	inclus	<b>55 €</b>	<b>62 €</b>	<b>92 €</b>	<b>53 €</b>

Hauteur de travail = hauteur du pied + bandeau

Les valeurs indiquées se réfèrent à des charges statiques. NB: Les roulettes ne sont pas recommandées pour des tables de soudure à 6 pieds. Pied à roulette non autorisé pour les tables de 1200 x 800 mm en raison du risque de basculement.

## Sets Basic



	280604	280511	280420.N	280110.N	280162.N
<b>1</b>	4-281200	4x	8x	6x	2x
<b>2</b>	4-281300	8x	12x	8x	4x
<b>3</b>	4-281400	10x	18x	10x	6x

## Basic 8.7

- Acier pour outillage traité à cœur X8.7, nitruré plasma et revêtu BAR
- Épaisseur env. 24,5 – 27 mm
- Alésages Ø 28 mm, Alésages sur le dessus de la table avec quadrillage diagonal
- Filetage M12 sur 4 côtés tous les 200 mm
- y compris pieds standards



Dimensions de table	Pieds	Poids			Transport / Emballage
1000 x 1000 mm	4	236 kg	<b>1.381 €</b>	4-281010.XD7	● 299 €
1200 x 800 mm	4	229 kg	<b>1.375 €</b>	4-281025.XD7	● 299 €
1200 x 1200 mm	4	325 kg	<b>1.670 €</b>	4-281015.XD7	● 345 €
1500 x 1000 mm	4	340 kg	<b>1.681 €</b>	4-281035.XD7	● 345 €
2000 x 1000 mm	5	442 kg	<b>2.170 €</b>	4-281020.XD7	● 410 €
2000 x 1200 mm	5	527 kg	<b>2.458 €</b>	4-281060.XD7	● 410 €
2400 x 1200 mm	6	636 kg	<b>2.777 €</b>	4-281030.XD7	● 429 €
3000 x 1500 mm	6	948 kg	<b>3.847 €</b>	4-281040.XD7	● 488 €

Poids = Table + Palette + Pied standard  
 Charge statique totale conseillée pour 4 pieds 2000 kg avec une répartition uniforme de la charge. (Données pour pied standard)



[www.siegmund.com/  
F-tablebasicX728](http://www.siegmund.com/F-tablebasicX728)



280543

8x

8x

8x



160415

8x

8x

8x



284050.Set

2x

4x



283999

1x

1x

1x

**1.149 €** ●

**1.735 €** ●

**3.070 €** ●

# Professional 750

- Acier de qualité S355J2+N, nitruré plasma et revêtu BAR
- Épaisseur env. 24,5 – 27 mm
- Alésages Ø 28 mm, Alésages sur le dessus de la table quadrillage 100x100 mm
- Hauteur des bandeaux 200 mm, Entraxe alésages bandeau 50 mm
- y compris pieds standards



Dimensions de table	Pieds	Poids			Transport / Emballage
1000 x 1000 mm	4	416 kg	<b>2.321 €</b>	4-280010.P	● 300 €
1200 x 800 mm	4	408 kg	<b>2.315 €</b>	4-280025.P	● 300 €
1200 x 1200 mm	4	544 kg	<b>3.137 €</b>	4-280015.P	● 345 €
1500 x 1000 mm	4	577 kg	<b>3.226 €</b>	4-280035.P	● 375 €
1500 x 1500 mm	4	801 kg	<b>4.288 €</b>	4-280050.P	● 395 €
2000 x 1000 mm	4	730 kg	<b>3.823 €</b>	4-280020.P	● 410 €
2000 x 1200 mm	4	843 kg	<b>4.376 €</b>	4-280060.P	● 429 €
2000 x 2000 mm	4	1299 kg	<b>6.763 €</b>	4-280045.P	● 475 €
2400 x 1200 mm	4	986 kg	<b>4.925 €</b>	4-280030.P	● 475 €
3000 x 1500 mm	6	1517 kg	<b>7.223 €</b>	4-280040.P	● 550 €
4000 x 2000 mm	8	2501 kg	<b>10.994 €</b>	4-280055.P	● 813 €



www.siegmund.com/  
F-table75028

Poids = Table + Palette + Pied standard  
Charge statique totale conseillée pour 4 pieds 4000 kg avec une répartition uniforme de la charge. (Données pour pied standard)  
Toutes nos tables sont disponibles sur commande sans nitruration plasma ou avec quadrillage diagonal: www.siegmund.com/F-table75028

## Pieds de table



	Equipement standard	Equipement standard	Réglable en hauteur	Réglable en hauteur	Sur roulette avec frein de blocage	Sur roulette réglable en hauteur avec frein de blocage	Ancrage au sol	Ancrage au sol
	280858.X	280857.X	4-280878.XX	4-280877.XX	4-280876.XX	4-280879.XX	4-280874.XX	4-280875.XX
Charge par pied	2000 kg	2000 kg	2000 kg	2000 kg	800 kg	800 kg	2000 kg	2000 kg
Hauteur des pieds	650 mm	750 mm	450 – 700 mm	550 – 900 mm	650 mm	550 – 750 mm	650 mm	750 mm
Réglage fin	50 mm	50 mm	50 mm	50 mm	20 mm	20 mm	50 mm	50 mm
Surcoût par pied	inclus	Alternativement	<b>78 €</b>	<b>80 €</b>	<b>101 €</b>	<b>131 €</b>	<b>53 €</b>	<b>53 €</b>

Hauteur de travail = hauteur du pied + bandeau  
Les valeurs indiquées se réfèrent à des charges statiques. NB: Les roulettes ne sont pas recommandées pour des tables de soudure à 6 ou 8 pieds.

## Sets



		280610.N	280630.N	280648.1.N	280511	280740	280410.N	280420.N	280430.N
<b>1</b>	4-283100	4x	2x	2x	12x		4x	4x	
<b>2</b>	4-283200	6x	4x	4x	18x	4x	6x	6x	
<b>3</b>	4-283300	10x	6x	4x	24x	4x	8x	8x	
<b>4</b>	4-283400	14x	10x	6x	30x	8x	10x	10x	4x
<b>5</b>	4-283500	14x	10x	8x	36x	8x	12x	12x	4x

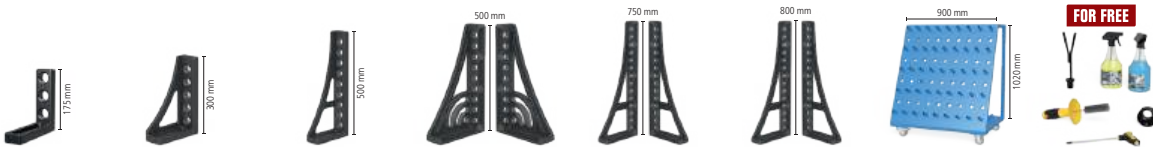
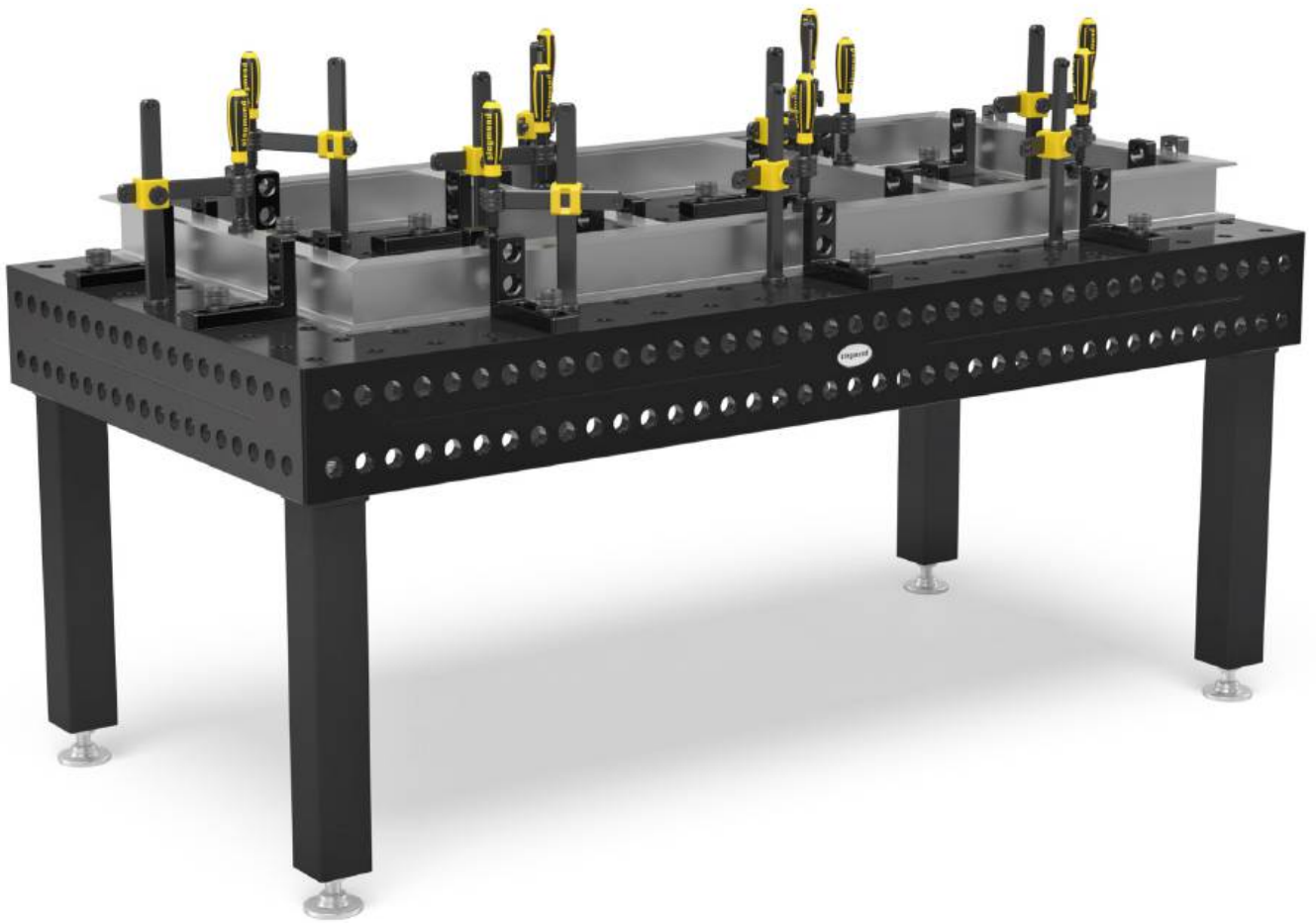

280110.N	280152.N	280162.N	280164+65.N	280166+67.N	280144+46.N	280910	283999	
2x	2x						1x	<b>1.842 €</b> •
4x	2x	2x					1x	<b>3.250 €</b> •
6x	2x	2x		1x			1x	<b>4.690 €</b> •
8x	2x	2x	1x	1x		1x	1x	<b>7.377 €</b> •
12x	2x	2x	1x	1x	1x	1x	1x	<b>8.998 €</b> •



# Professional Extreme 8.7

- Acier pour outillage traité à cœur X8.7, nitruré plasma et revêtu BAR
- Épaisseur env. 24,5 – 27 mm
- Alésages Ø 28 mm, Alésages sur le dessus de la table avec quadrillage diagonal
- Hauteur des bandeaux 200 mm, Alésages sur bandeau de table avec quadrillage diagonal
- Bandeaux en acier de haute qualité S355J2+N
- y compris pieds standards



Dimensions de table	Pieds	Poids		Transport / Emballage
1000 x 1000 mm	4	400 kg	<b>2.898 €</b>	4-280010.XD7D ● 300 €
1200 x 800 mm	4	392 kg	<b>2.891 €</b>	4-280025.XD7D ● 300 €
1200 x 1200 mm	4	521 kg	<b>3.703 €</b>	4-280015.XD7D ● 345 €
1500 x 1000 mm	4	554 kg	<b>3.982 €</b>	4-280035.XD7D ● 375 €
1500 x 1500 mm	4	767 kg	<b>5.231 €</b>	4-280050.XD7D ● 395 €
2000 x 1000 mm	4	699 kg	<b>4.724 €</b>	4-280020.XD7D ● 410 €
2000 x 1200 mm	4	806 kg	<b>5.331 €</b>	4-280060.XD7D ● 429 €
2000 x 2000 mm	4	1240 kg	<b>8.137 €</b>	4-280045.XD7D ● 475 €
2400 x 1200 mm	4	947 kg	<b>6.039 €</b>	4-280030.XD7D ● 475 €
3000 x 1500 mm	6	1425 kg	<b>8.666 €</b>	4-280040.XD7D ● 550 €
4000 x 2000 mm	8	2384 kg	<b>13.463 €</b>	4-280055.XD7D ● 813 €
4800 x 2400 mm	11	3275 kg	<b>19.422 €</b>	4-280065.XD7D ○



www.siegmund.com/  
F-tableX728

Poids = Table + Palette + Pied standard  
Charge statique totale conseillée pour 4 pieds 4000 kg avec une répartition uniforme de la charge. (Données pour pied standard)  
Toutes nos tables sont disponibles sur commande sans nitruration plasma et avec un quadrillage 100x100 mm: www.siegmund.com/F-tableX728

## Pieds de table



	Equipement standard	Equipement standard	Réglable en hauteur	Réglable en hauteur	Sur roulette avec frein de blocage	Sur roulette réglable en hauteur avec frein de blocage	Ancrage au sol	Ancrage au sol
	280858.X	280857.X	4-280878.XX	4-280877.XX	4-280876.XX	4-280879.XX	4-280874.XX	4-280875.XX
Charge par pied	2000 kg	2000 kg	2000 kg	2000 kg	800 kg	800 kg	2000 kg	2000 kg
Hauteur des pieds	650 mm	750 mm	450 – 700 mm	550 – 900 mm	650 mm	550 – 750 mm	650 mm	750 mm
Réglage fin	50 mm	50 mm	50 mm	50 mm	20 mm	20 mm	50 mm	50 mm
Surcoût par pied	inclus	Alternativement	<b>78 €</b>	<b>80 €</b>	<b>101 €</b>	<b>131 €</b>	<b>53 €</b>	<b>53 €</b>

Hauteur de travail = hauteur du pied + bandeau  
Les valeurs indiquées se réfèrent à des charges statiques. NB: Les roulettes ne sont pas recommandées pour des tables de soudure à 6 ou 8 pieds.

## Sets



	280610.N	280630.N	280648.1.N	280511	280740	280410.N	280420.N	280430.N
<b>1</b>	4-283100	4x	2x	2x	12x	4x	4x	
<b>2</b>	4-283200	6x	4x	4x	18x	4x	6x	
<b>3</b>	4-283300	10x	6x	4x	24x	4x	8x	
<b>4</b>	4-283400	14x	10x	6x	30x	8x	10x	4x
<b>5</b>	4-283500	14x	10x	8x	36x	8x	12x	4x

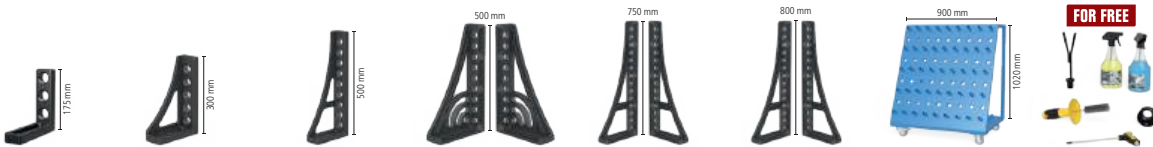

280110.N	280152.N	280162.N	280164+65.N	280166+67.N	280144+46.N	280910	283999	
2x	2x						1x	<b>1.842 €</b> •
4x	2x	2x					1x	<b>3.250 €</b> •
6x	2x	2x		1x			1x	<b>4.690 €</b> •
8x	2x	2x	1x	1x		1x	1x	<b>7.377 €</b> •
12x	2x	2x	1x	1x	1x	1x	1x	<b>8.998 €</b> •



# Professional Extreme 8.8 PLUS

- Acier pour outillage traité à cœur X8.8, nitruré plasma plus traitement de surface BAR
- Épaisseur env. 24,5 – 27 mm
- Alésages Ø 28 mm, Alésages sur le dessus de la table avec quadrillage diagonal
- Hauteur des bandeaux 300 mm, Alésages sur les bandeaux 3 lignes entraxe 50 mm, 2 lignes entraxe 100 mm
- Bandeaux en acier de haute qualité S355J2+N
- y compris pieds standards



Dimensions de table	Pieds	Poids			Transport / Emballage
1200 x 1200 mm	4	612 kg	<b>4.124 €</b>	4-280015.XD8PL	● 345 €
1500 x 1000 mm	4	655 kg	<b>4.448 €</b>	4-280035.XD8PL	● 375 €
1500 x 1500 mm	4	901 kg	<b>5.809 €</b>	4-280050.XD8PL	● 395 €
2000 x 1000 mm	4	826 kg	<b>5.246 €</b>	4-280020.XD8PL	● 410 €
2400 x 1200 mm	4	1102 kg	<b>6.669 €</b>	4-280030.XD8PL	● 475 €
3000 x 1500 mm	6	1656 kg	<b>9.536 €</b>	4-280040.XD8PL	● 550 €
4000 x 2000 mm	8	2746 kg	<b>14.713 €</b>	4-280055.XD8PL	● 813 €



Poids = Table + Palette + Pied standard  
 Charge statique totale conseillée pour 4 pieds 6000 kg avec une répartition uniforme de la charge. (Données pour pied standard)  
 Toutes nos tables sont disponibles sur commande sans nitruration plasma: [www.siegmund.com/F-tableX828plus](http://www.siegmund.com/F-tableX828plus)



[www.siegmund.com/  
F-tableX828plus](http://www.siegmund.com/F-tableX828plus)

## Pieds de table



	Equipement standard	Equipement standard	Réglable en hauteur	Réglable en hauteur	Sur roulette avec frein de blocage	Sur roulette réglable en hauteur avec frein de blocage	Ancre au sol
	280853.X	280857.X	4-280878.XX	4-280877.XX	4-280860.XX	4-280879.XX	4-280872.XX
Charge par pied	3000 kg	2000 kg	2000 kg	2000 kg	800 kg	800 kg	3000 kg
Hauteur des pieds	550 mm	750 mm	450 – 700 mm	550 – 900 mm	550 mm	550 – 750 mm	550 mm
Réglage fin	50 mm	50 mm	50 mm	50 mm	20 mm	20 mm	50 mm
Surcoût par pied	inclus	Alternativement	<b>78 €</b>	<b>80 €</b>	<b>99 €</b>	<b>131 €</b>	<b>53 €</b>

Hauteur de travail = hauteur du pied + bandeau  
 Les valeurs indiquées se réfèrent à des charges statiques. NB: Les roulettes ne sont pas recommandées pour des tables de soudure à 6 ou 8 pieds.

## Sets



		280610.N	280630.N	280648.1.N	280511	280740	280410.N	280420.N	280430.N
<b>1</b>	4-283100	4x	2x	2x	12x		4x	4x	
<b>2</b>	4-283200	6x	4x	4x	18x	4x	6x	6x	
<b>3</b>	4-283300	10x	6x	4x	24x	4x	8x	8x	
<b>4</b>	4-283400	14x	10x	6x	30x	8x	10x	10x	4x
<b>5</b>	4-283500	14x	10x	8x	36x	8x	12x	12x	4x

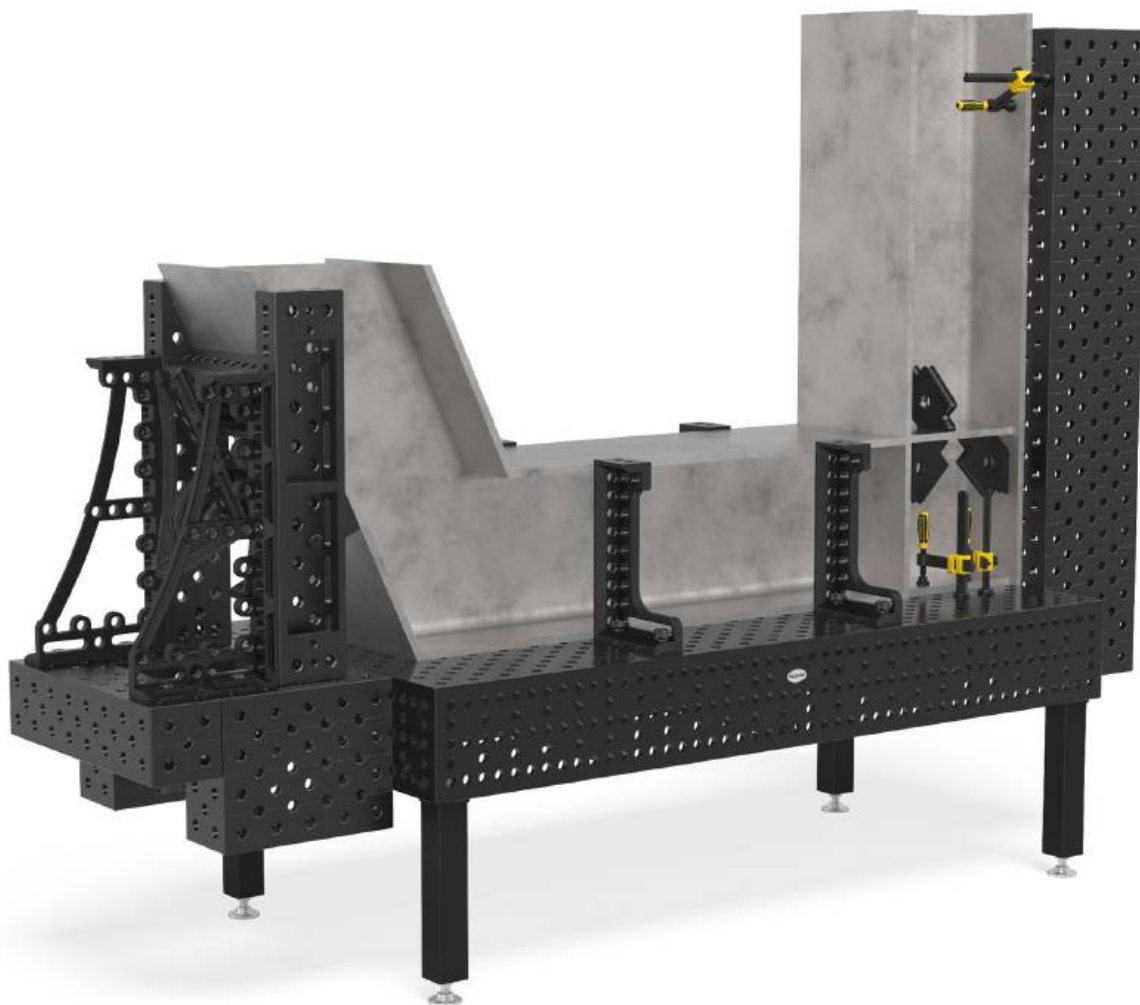

280110.N

2x



280152.N

2x



280162.N

2x



280164+65.N

1x



280166+67.N

1x



280144+46.N

1x

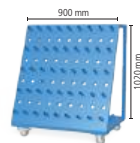

280910

1x



283999

1x

1.842 € •

3.250 € •

4.690 € •

7.377 € •

8.998 € •

# PROMOS EXCLUSIVES

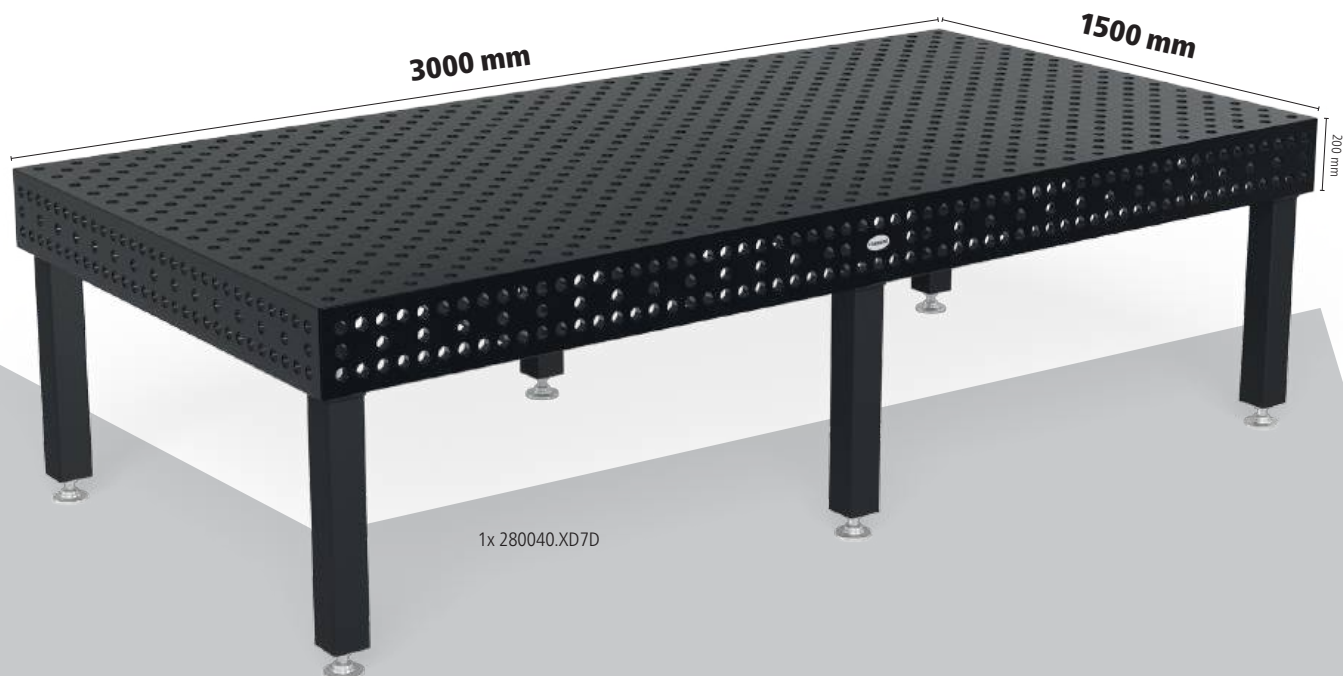

6x 280610.N

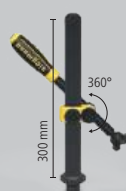

2x 280630.N



12x 280511



4x 280740



6x 280410.N



4x 280420.N



4x 280110.N



2x 280152.N



2x 280162.N



4x 280648.1.N



1x 280990.1



FOR FREE 1x 283999



## Table de soudure et de bridage Extreme 8.7

### Accessoires compris

- Acier pour outillage traité à cœur X8.7 + Nitruration plasma
- Bandeaux en acier de haute qualité S355J2+N + Nitruration plasma
- Alésages Ø 28 mm
- Alésages sur le dessus de la table avec quadrillage diagonal
- Épaisseur env. 24,5 – 27 mm
- Hauteur des bandeaux 200 mm
- Alésages sur bandeau de table avec quadrillage diagonal
- Coins, bords et alésage System arrondis
- Graduation comprise sur le dessus de la table
- Châssis renforcé par des traverses

Prix Promo **0%**

**11.388 €**  
au lieu de 12.245 €

4-288340.XD7D



## Table de soudure et de bridage Extreme 8.7

### Accessoires compris

- Acier pour outillage traité à cœur X8.7 + Nitruration plasma
- Bandeaux en acier de haute qualité S355J2+N + Nitruration plasma
- Alésages Ø 28 mm
- Alésages sur le dessus de la table avec quadrillage diagonal
- Épaisseur env. 24,5 – 27 mm
- Hauteur des bandeaux 200 mm
- Alésages sur bandeau de table avec quadrillage diagonal
- Coins, bords et alésage System arrondis
- Graduation comprise sur le dessus de la table
- Châssis renforcé par des traverses

Prix Promo **%**

**8.045 €**

au lieu de 8.650 €

4-288130.XD7D



1x 280030.XD7D

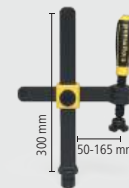

6x 280610.N



2x 280630.N



12x 280511



4x 280740



4x 280410.N



4x 280420.N



4x 280110.N



2x 280152.N



4x 280648.1.N



**FOR FREE** 1x 283999

## Table à rainures hexagonales

- Acier pour outillage traité à cœur X8.7, nitruré plasma et revêtu BAR
- Épaisseur env. 24,5 – 27 mm
- Rainure hexagonale entraxe 100 mm
- Alésages Ø 28 mm, Alésages sur le dessus de la table quadrillage 100x100 mm
- Hauteur des bandeaux 200 mm, Alésages sur bandeau de table avec quadrillage diagonal
- Bandeaux en acier de haute qualité S355J2+N
- y compris pieds standards



Dimensions de table	Pieds	Poids			Transport / Emballage
1200 x 1200 mm	4	500 kg	<b>4.034 €</b>	4-280015.HNK	● 345 €
1500 x 1000 mm	4	531 kg	<b>4.308 €</b>	4-280035.HNK	● 375 €
1500 x 1500 mm	4	734 kg	<b>5.565 €</b>	4-280050.HNK	● 395 €
2000 x 1000 mm	4	668 kg	<b>5.174 €</b>	4-280020.HNK	● 410 €
2400 x 1200 mm	6	920 kg	<b>6.388 €</b>	4-280030.HNK	● 475 €
3000 x 1500 mm	6	1356 kg	<b>9.440 €</b>	4-280040.HNK	● 550 €
4000 x 2000 mm	8	2262 kg	<b>14.726 €</b>	4-280055.HNK	● 813 €



Poids = Table + Palette + Pied standard  
 Charge statique totale conseillée pour 4 pieds 4000 kg avec une répartition uniforme de la charge. (Données pour pied standard)



www.siegmund.com/  
 F-hexagontable

### Gratuit pour toutes les tables à rainures hexagonales

- HN283999:
- 4x HN280547 Taquet 25 mm
- 4x 280546.4 Douille de bridage



### Pieds de table



	Equipement standard	Equipement standard	Réglable en hauteur	Réglable en hauteur	Sur roulette avec frein de blocage	Sur roulette réglable en hauteur avec frein de blocage	Ancrage au sol	Ancrage au sol
	280858.X	280857.X	4-280878.XX	4-280877.XX	4-280876.XX	4-280879.XX	4-280874.XX	4-280875.XX
Charge par pied	2000 kg	2000 kg	2000 kg	2000 kg	800 kg	800 kg	2000 kg	2000 kg
Hauteur des pieds	650 mm	750 mm	450 – 700 mm	550 – 900 mm	650 mm	550 – 750 mm	650 mm	750 mm
Réglage fin	50 mm	50 mm	50 mm	50 mm	20 mm	20 mm	50 mm	50 mm
Surcoût par pied	inclus	Alternativement	<b>78 €</b>	<b>80 €</b>	<b>101 €</b>	<b>131 €</b>	<b>53 €</b>	<b>53 €</b>

Hauteur de travail = hauteur du pied + bandeau  
 Les valeurs indiquées se réfèrent à des charges statiques. NB: Les roulettes ne sont pas recommandées pour des tables de soudure à 6 ou 8 pieds.

### Sets



	280610.N	280630.N	280648.1.N	280511	280740	280410.N	280420.N	280430.N
<b>1</b>	4-283100	4x	2x	2x	12x	4x	4x	
<b>2</b>	4-283200	6x	4x	4x	18x	4x	6x	
<b>3</b>	4-283300	10x	6x	4x	24x	4x	8x	
<b>4</b>	4-283400	14x	10x	6x	30x	8x	10x	4x
<b>5</b>	4-283500	14x	10x	8x	36x	8x	12x	4x



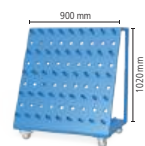
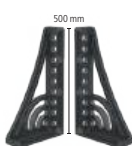
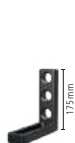
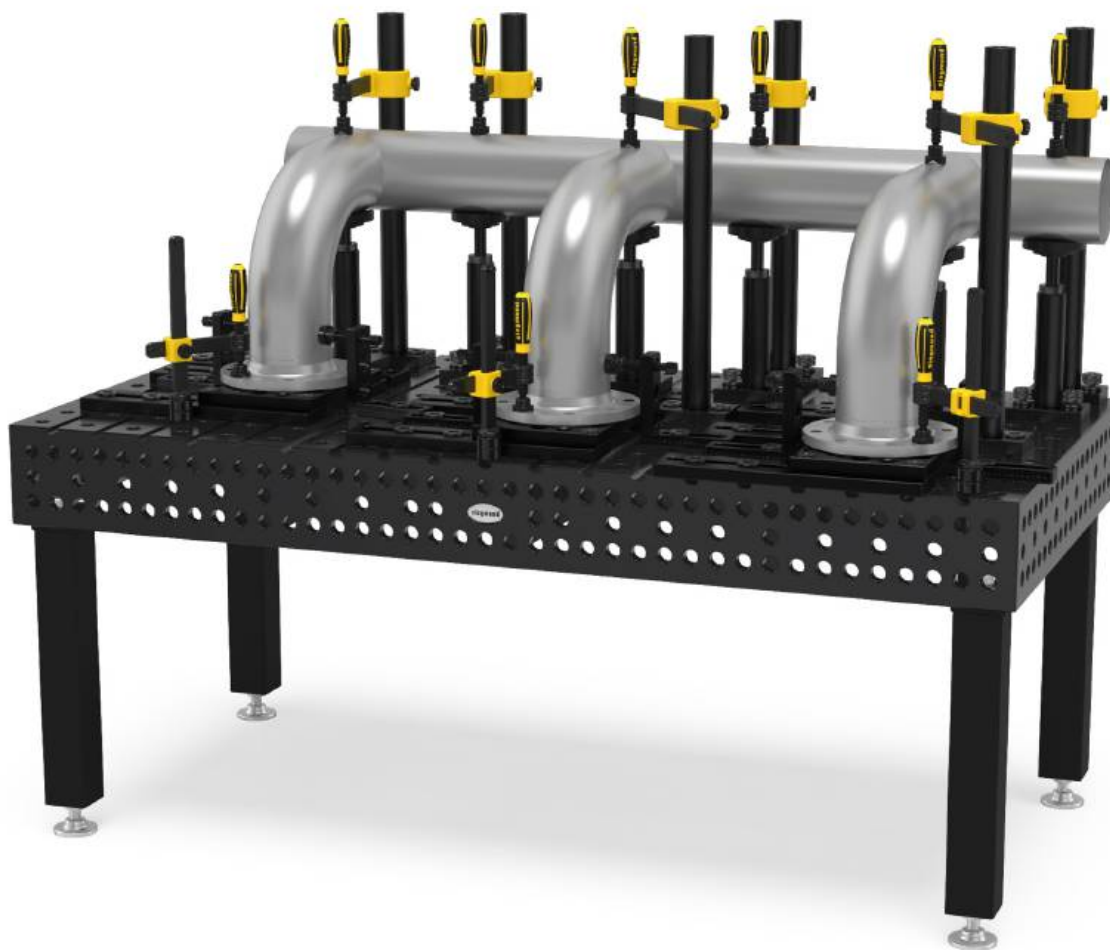

280110.N	280152.N	280162.N	280164+65.N	280166+67.N	280144+46.N	280910	283999	
2x	2x						1x	<b>1.842 €</b> •
4x	2x	2x					1x	<b>3.250 €</b> •
6x	2x	2x		1x			1x	<b>4.690 €</b> •
8x	2x	2x	1x	1x		1x	1x	<b>7.377 €</b> •
12x	2x	2x	1x	1x	1x	1x	1x	<b>8.998 €</b> •



# MONTAGES MI-LOURDS

Pour des constructions soudées légères ou moyennes,  
nous conseillons le Systeme 22.

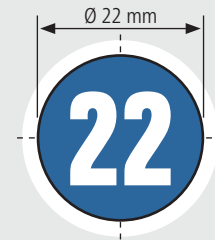

**Charge maxi conseillée  
jusqu'à 3000 kg**  
charge max pour pied standard 1500 kg

# Professional 750

- Acier de qualité S355J2+N, nitruré plasma et revêtu BAR
- Épaisseur env. 17 – 19 mm
- Alésages Ø 22 mm, Alésages sur le dessus de la table quadrillage 100x100 mm
- Hauteur des bandeaux 150 mm, Entraxe alésages bandeau 50 mm
- y compris pieds standards



Dimensions de table	Pieds	Poids			Transport / Emballage
1000 x 1000 mm	4	301 kg	<b>1.756 €</b>	4-220010.P	● 300 €
1200 x 1200 mm	4	395 kg	<b>2.264 €</b>	4-220015.P	● 345 €
1500 x 1000 mm	4	420 kg	<b>2.282 €</b>	4-220035.P	● 375 €
1500 x 1500 mm	4	585 kg	<b>3.228 €</b>	4-220050.P	● 395 €
2000 x 1000 mm	4	529 kg	<b>2.888 €</b>	4-220020.P	● 410 €
2400 x 1200 mm	6	740 kg	<b>3.724 €</b>	4-220030.P	● 475 €
3000 x 1500 mm	6	1097 kg	<b>5.430 €</b>	4-220040.P	● 550 €



Poids = Table + Palette + Pied standard  
 Charge statique totale conseillée pour 4 pieds 3000 kg avec une répartition uniforme de la charge. (Données pour pied standard)  
 Toutes nos tables sont disponibles sur commande sans nitruration plasma ou avec quadrillage diagonal: [www.siegmund.com/F-table75022](http://www.siegmund.com/F-table75022)



[www.siegmund.com/F-table75022](http://www.siegmund.com/F-table75022)

## Pieds de table



	Equipement standard	Equipement standard	Réglable en hauteur	Réglable en hauteur	Sur roulette avec frein de blocage	Sur roulette réglable en hauteur avec frein de blocage	Ancre au sol
	220858	220857.X	4-220878.XX	4-220877.XX	4-220866.XX	4-220879.XX	4-220874.XX
Charge par pied	1500 kg	1500 kg	1000 kg	1000 kg	800 kg	800 kg	1500 kg
Hauteur des pieds	700 mm	800 mm	500 – 800 mm	550 – 900 mm	700 mm	600 – 850 mm	700 mm
Réglage fin	50 mm	50 mm	50 mm	50 mm	20 mm	20 mm	50 mm
Surcoût par pied	inclus	Alternativement	<b>68 €</b>	<b>69 €</b>	<b>95 €</b>	<b>114 €</b>	<b>53 €</b>





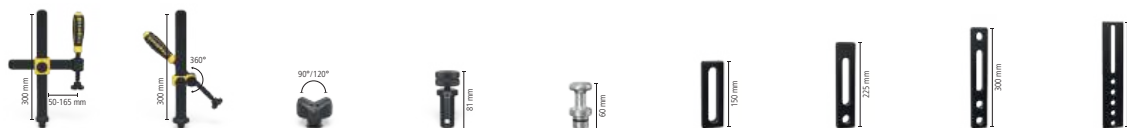

Hauteur de travail = hauteur du pied + bandeau  
 Les valeurs indiquées se réfèrent à des charges statiques. NB: Les roulettes ne sont pas recommandées pour des tables de soudure à 6 ou 8 pieds.

## Sets



		220610.1	220630.1	220645.1	220511	220740	220410.N	220420.N	220426.N	220430.N
<b>1</b>	4-223100	4x	2x		12x		4x	4x		
<b>2</b>	4-223200	6x	4x	4x	18x	4x	6x	6x	2x	
<b>3</b>	4-223300	10x	6x	4x	24x	4x	8x	8x	2x	
<b>4</b>	4-223400	12x	8x	8x	30x	8x	10x	10x	2x	2x
<b>5</b>	4-223500	14x	10x	8x	30x	8x	12x	12x	4x	4x

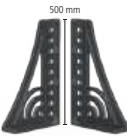
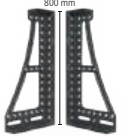
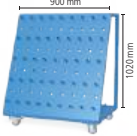

								
220110.N	220152.N	220116.N	220162.N	220164+65.N	220144+46.N	220910	223999	
2x	2x						1x	<b>1.485 €</b> •
4x	2x						1x	<b>2.582 €</b> •
6x	2x						1x	<b>3.472 €</b> •
8x		2x	2x	1x		1x	1x	<b>5.743 €</b> •
10x		2x	2x	1x	1x	1x	1x	<b>7.307 €</b> •

# Professional Extreme 8.7

- Acier pour outillage traité à cœur X8.7, nitruré plasma et revêtu BAR
- Épaisseur env. 17 – 19 mm
- Alésages Ø 22 mm, Alésages sur le dessus de la table avec quadrillage diagonal
- Hauteur des bandeaux 150 mm, Entraxe alésages bandeau 50 mm
- Bandeaux en acier de haute qualité S355J2+N
- y compris pieds standards



Dimensions de table	Pieds	Poids			Transport / Emballage
1000 x 1000 mm	4	295 kg	<b>2.036 €</b>	4-220010.XD7	• 300 €
1200 x 800 mm	4	291 kg	<b>2.032 €</b>	4-220025.XD7	• 300 €
1200 x 1200 mm	4	387 kg	<b>2.628 €</b>	4-220015.XD7	• 345 €
1500 x 1000 mm	4	412 kg	<b>2.653 €</b>	4-220035.XD7	• 375 €
1500 x 1500 mm	4	573 kg	<b>3.755 €</b>	4-220050.XD7	• 395 €
2000 x 1000 mm	4	519 kg	<b>3.356 €</b>	4-220020.XD7	• 410 €
2000 x 1200 mm	4	602 kg	<b>3.923 €</b>	4-220060.XD7	• 429 €
2000 x 2000 mm	4	929 kg	<b>5.496 €</b>	4-220045.XD7	• 475 €
2400 x 1200 mm	6	725 kg	<b>4.346 €</b>	4-220030.XD7	• 475 €
3000 x 1500 mm	6	1073 kg	<b>6.345 €</b>	4-220040.XD7	• 550 €
4000 x 2000 mm	8	1807 kg	<b>10.549 €</b>	4-220055.XD7	• 813 €



www.siegmund.com/  
F-tableX722

Poids = Table + Palette + Pied standard  
Charge statique totale conseillée pour 4 pieds 3000 kg avec une répartition uniforme de la charge. (Données pour pied standard)

## Pieds de table



	Equipement standard	Equipement standard	Réglable en hauteur	Réglable en hauteur	Sur roulette avec frein de blocage	Sur roulette réglable en hauteur avec frein de blocage	Ancre au sol
	220858	220857.X	4-220878.XX	4-220877.XX	4-220866.XX	4-220879.XX	4-220874.XX
Charge par pied	1500 kg	1500 kg	1000 kg	1000 kg	800 kg	800 kg	1500 kg
Hauteur des pieds	700 mm	800 mm	500 – 800 mm	550 – 900 mm	700 mm	600 – 850 mm	700 mm
Réglage fin	50 mm	50 mm	50 mm	50 mm	20 mm	20 mm	50 mm
Surcoût par pied	inclus	Alternativement	<b>68 €</b>	<b>69 €</b>	<b>95 €</b>	<b>114 €</b>	<b>53 €</b>

Hauteur de travail = hauteur du pied + bandeau  
Les valeurs indiquées se réfèrent à des charges statiques. NB: Les roulettes ne sont pas recommandées pour des tables de soudure à 6 ou 8 pieds.

## Sets

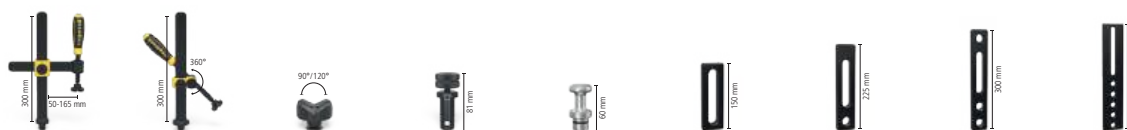

	220610.1	220630.1	220645.1	220511	220740	220410.N	220420.N	220426.N	220430.N
<b>1</b>	4-223100	4x	2x	12x		4x	4x		
<b>2</b>	4-223200	6x	4x	4x	18x	4x	6x	6x	2x
<b>3</b>	4-223300	10x	6x	4x	24x	4x	8x	8x	2x
<b>4</b>	4-223400	12x	8x	8x	30x	8x	10x	10x	2x
<b>5</b>	4-223500	14x	10x	8x	30x	8x	12x	12x	4x

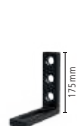
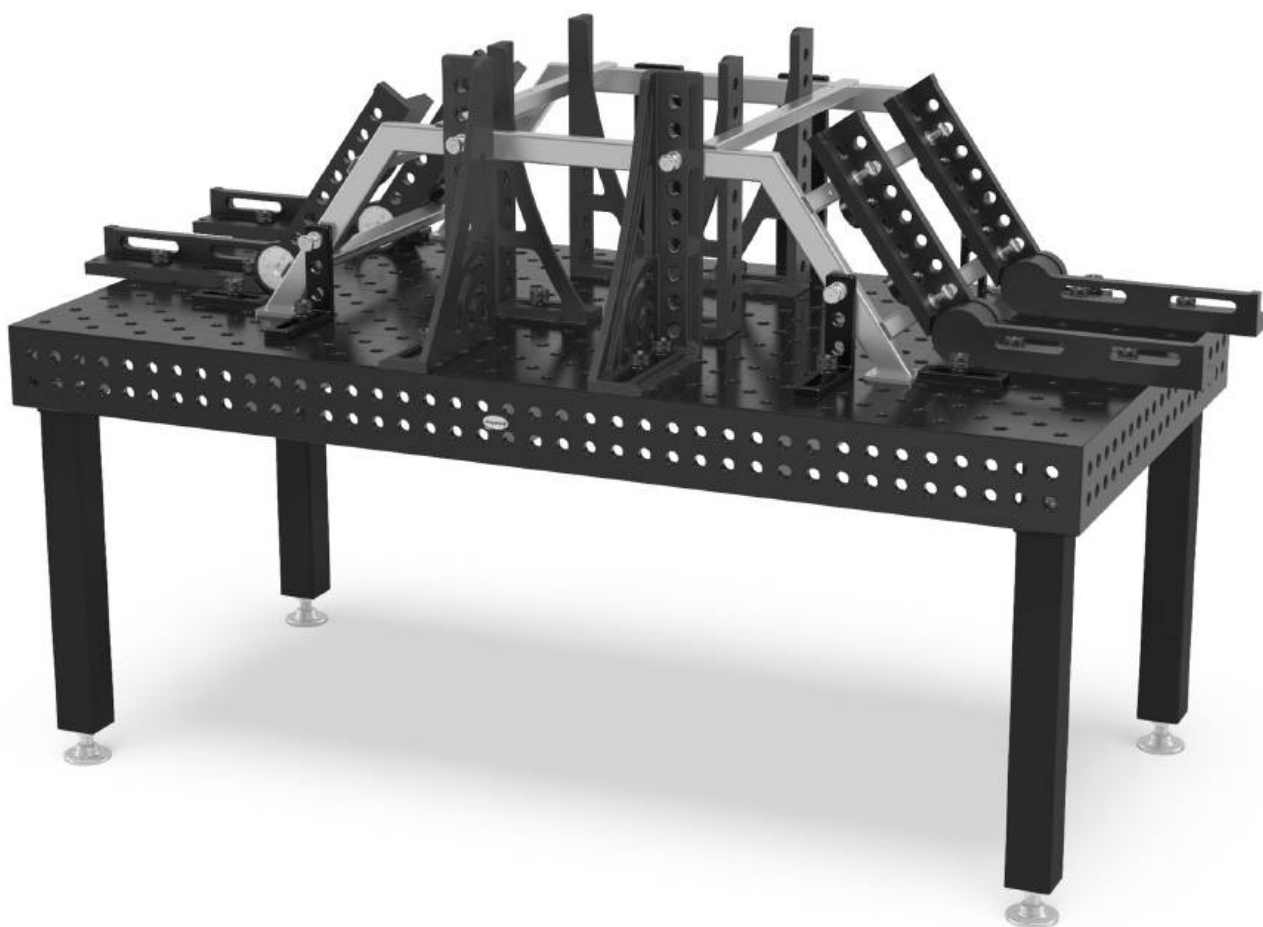

220110.N

2x



220152.N

2x



220116.N

2x

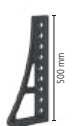

220162.N

2x

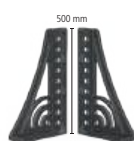

220164+65.N

1x

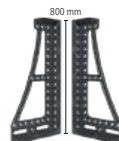

220144+46.N

1x

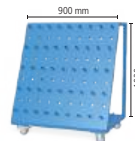

220910

1x



223999

1x

1.485 € •

2.582 € •

3.472 € •

5.743 € •

7.307 € •

# Professional Extreme 8.7 PLUS

- Acier pour outillage traité à cœur X8.7, nitruré plasma et revêtu BAR
- Épaisseur env. 17 – 19 mm
- Alésages Ø 22 mm, Alésages sur le dessus de la table avec quadrillage diagonal
- Hauteur des bandeaux 250 mm, Alésages sur les bandeaux 4 lignes avec entraxe de 50 mm
- Bandeaux en acier de haute qualité S355J2+N
- y compris pieds standards



Dimensions de table	Pieds	Poids		Transport / Emballage
1200 x 1200 mm	4	459 kg	<b>2.904 €</b>	4-220015.XD7PL ● 345 €
1500 x 1000 mm	4	493 kg	<b>2.931 €</b>	4-220035.XD7PL ● 375 €
2000 x 1000 mm	4	622 kg	<b>3.709 €</b>	4-220020.XD7PL ● 410 €
2400 x 1200 mm	6	849 kg	<b>4.769 €</b>	4-220030.XD7PL ● 475 €
3000 x 1500 mm	6	1267 kg	<b>7.304 €</b>	4-220040.XD7PL ● 550 €
4000 x 2000 mm	8	2115 kg	<b>11.570 €</b>	4-220055.XD7PL ● 813 €



Poids = Table + Palette + Pied standard  
 Charge statique totale conseillée pour 4 pieds 3000 kg avec une répartition uniforme de la charge. (Données pour pied standard)  
 Toutes nos tables sont disponibles sur commande sans nitruration plasma: [www.siegmund.com/F-tableX722plus](http://www.siegmund.com/F-tableX722plus)



[www.siegmund.com/F-tableX722plus](http://www.siegmund.com/F-tableX722plus)

## Pieds de table



	Equipement standard	Equipement standard	Réglable en hauteur	Réglable en hauteur	Sur roulette avec frein de blocage	Sur roulette réglable en hauteur avec frein de blocage	Ancre au sol
	220853.X	220857.X	4-220878.XX	4-220877.XX	4-220860.XX	4-220879.XX	4-220872.XX
Charge par pied	1500 kg	1500 kg	1000 kg	1000 kg	800 kg	800 kg	1500 kg
Hauteur des pieds	600 mm	800 mm	500 – 800 mm	550 – 900 mm	600 mm	600 – 850 mm	600 mm
Réglage fin	50 mm	50 mm	50 mm	50 mm	20 mm	20 mm	50 mm
Surcoût par pied	inclus	Alternativement	<b>68 €</b>	<b>69 €</b>	<b>93 €</b>	<b>114 €</b>	<b>53 €</b>

Hauteur de travail = hauteur du pied + bandeau  
 Les valeurs indiquées se réfèrent à des charges statiques. NB: Les roulettes ne sont pas recommandées pour des tables de soudure à 6 ou 8 pieds.

## Sets

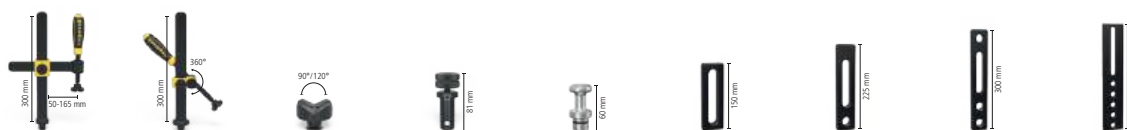

	220610.1	220630.1	220645.1	220511	220740	220410.N	220420.N	220426.N	220430.N	
<b>1</b>	4-223100	4x	2x	12x		4x	4x			
<b>2</b>	4-223200	6x	4x	4x	18x	4x	6x	6x	2x	
<b>3</b>	4-223300	10x	6x	4x	24x	4x	8x	8x	2x	
<b>4</b>	4-223400	12x	8x	8x	30x	8x	10x	10x	2x	2x
<b>5</b>	4-223500	14x	10x	8x	30x	8x	12x	12x	4x	4x



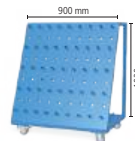
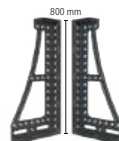
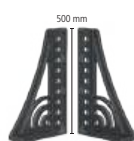
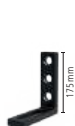

220110.N	220152.N	220116.N	220162.N	220164+65.N	220144+46.N	220910	223999	
2x	2x						1x	<b>1.485 €</b> •
4x	2x						1x	<b>2.582 €</b> •
6x	2x						1x	<b>3.472 €</b> •
8x		2x	2x	1x		1x	1x	<b>5.743 €</b> •
10x		2x	2x	1x	1x	1x	1x	<b>7.307 €</b> •

# PROMOS EXCLUSIVES

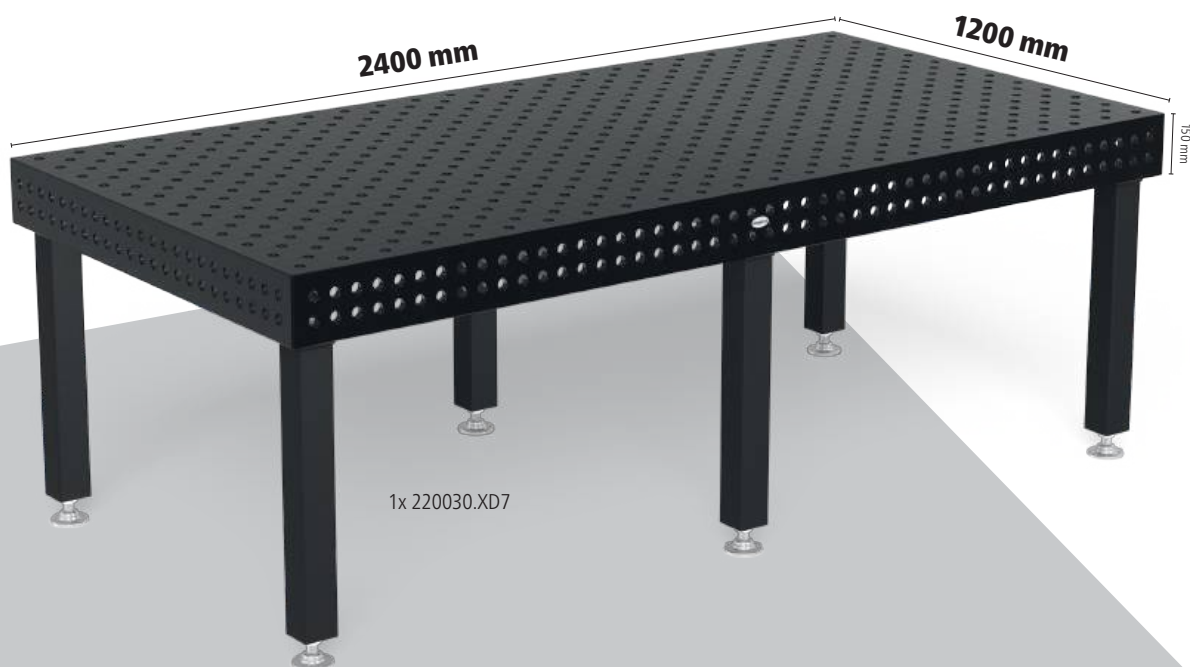

6x 220610.1

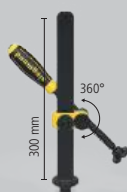

2x 220630.1



12x 220511



4x 220740



6x 220410.N



4x 220420.N



2x 220426.N



4x 220110.N



2x 220152.N



2x 220162.N



4x 220645.1

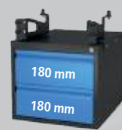

1x 220990.1



FOR FREE 1x 223999



## Table de soudure et de bridage Extreme 8.7

### Accessoires compris

- Acier pour outillage traité à cœur X8.7 + Nitruration plasma
- Bandeaux en acier de haute qualité S355J2+N + Nitruration plasma
- Alésages Ø 22 mm
- Alésages sur le dessus de la table avec quadrillage diagonal
- Épaisseur env. 17 – 19 mm
- Hauteur des bandeaux 150 mm
- Entraxe alésages bandeau 50 mm
- Coins, bords et alésage System arrondis
- Graduation comprise sur le dessus de la table
- Châssis renforcé par des traverses

Prix Promo

**6.873 €**

au lieu de 7.390 €

4-228330.XD7

Emballage / Transport 475 €



## Table de soudure et de bridage Professional 750

### Accessoires compris

- Acier de qualité S355J2+N + Nitruration plasma
- Alésages Ø 22 mm
- Alésages sur le dessus de la table quadrillage 100x100 mm
- Épaisseur env. 17 – 19 mm
- Hauteur des bandeaux 150 mm
- Entraxe alésages bandeau 50 mm
- Coins, bords et alésage System arrondis
- Graduation comprise sur le dessus de la table
- Châssis renforcé par des traverses

Prix Promo **0%**

**4.695 €**

au lieu de 5.048 €

4-228220.P

Emballage / Transport 410 €

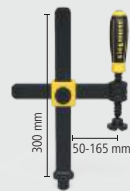
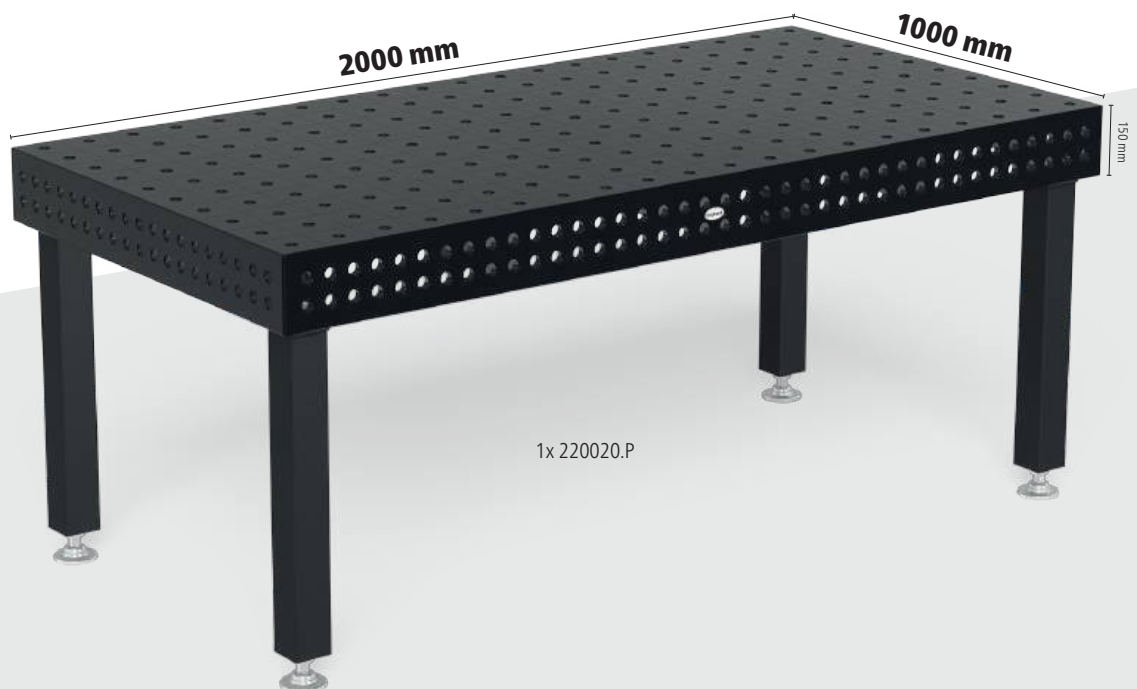

4x 220610.1

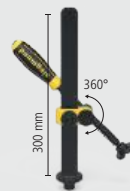

2x 220630.1



12x 220511



4x 220740



6x 220410.N



4x 220420.N



2x 220426.N



4x 220110.N



2x 220152.N



4x 220645.1



**FOR FREE** 1x 223999

# PETITS MONTAGES

Pour des pièces légères comme par exemple des garde-corps ou des cadres légers, le Systeme 16 est la bonne décision.

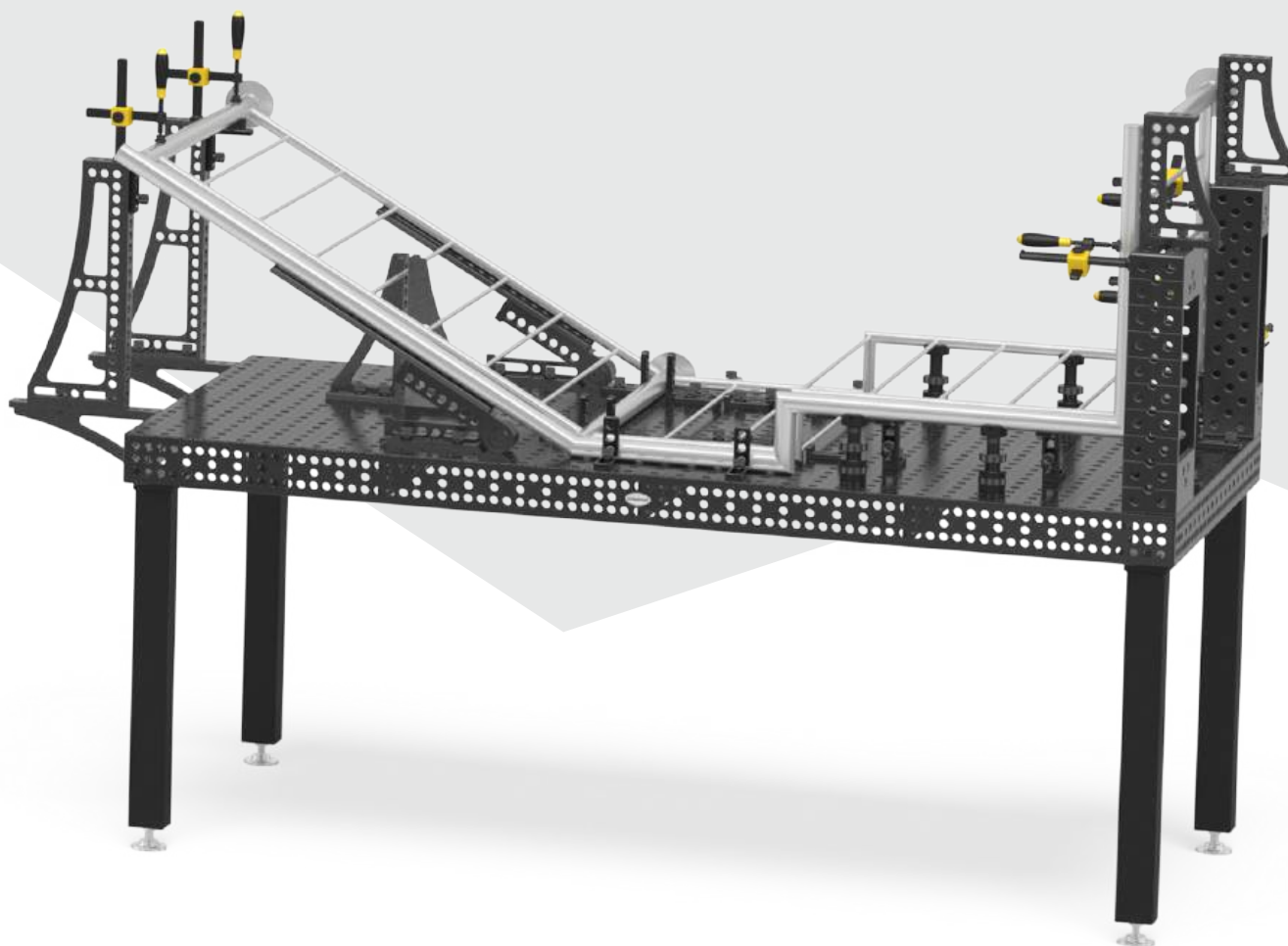
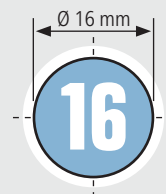

**Charge maxi conseillée  
jusqu'à 2000 kg**  
charge maxi par pied standard 1000 kg

# Basic 750

- Acier de qualité S355J2+N, nitruré plasma et revêtu BAR
- Épaisseur env. 11,5 – 13 mm
- Alésages Ø 16 mm, Alésages sur le dessus de la table quadrillage 50x50 mm
- Hauteur des bandeaux 50 mm, Entraxe alésages bandeau 50 mm
- y compris pieds standards



Dimensions de table	Pieds	Poids			Transport / Emballage
1000 x 1000 mm	4	183 kg	<b>1.326 €</b>	4-161010.P	• 260 €
1200 x 800 mm	4	173 kg	<b>1.326 €</b>	4-161025.P	• 254 €
1200 x 1200 mm	4	242 kg	<b>1.728 €</b>	4-161015.P	• 293 €
1500 x 1000 mm	4	244 kg	<b>1.849 €</b>	4-161035.P	• 293 €

Poids = Table + Palette + Pied standard  
 Charge statique totale conseillée pour 4 pieds 1000 kg avec une répartition uniforme de la charge. (Données pour pied standard)



[www.siegmund.com/  
F-tablebasic16](http://www.siegmund.com/F-tablebasic16)

## Pieds de table



	Equipement standard	Réglable en hauteur	Sur roulette avec frein de blocage	Sur roulette réglable en hauteur avec frein de blocage	Ancrage au sol
	161856	4-160877.XX	4-161855.XX	4-160879.XX	4-160874.XX
Charge par pied	1000 kg	1000 kg	200 kg	200 kg	1000 kg
Hauteur des pieds	815 mm	550 – 950 mm	815 mm	600 – 900 mm	815 mm
Réglage fin	50 mm	40 mm	30 mm	30 mm	50 mm
Surcoût par pied	inclus	<b>55 €</b>	<b>62 €</b>	<b>92 €</b>	<b>53 €</b>

Hauteur de travail = hauteur du pied + bandeau  
 Les valeurs indiquées se réfèrent à des charges statiques. NB: Les roulettes ne sont pas recommandées pour des tables de soudure à 6 pieds. Pied à roulette non autorisé pour les tables de 1200 x 800 mm en raison du risque de basculement.

## Sets Basic



	160610	160511	160420.N	160108.N	160110.N	160162.N	163999	
<b>1</b>	4-161200	4x	12x	8x	4x	2x	1x	<b>873 €</b> •
<b>2</b>	4-161300	8x	16x	10x	4x	4x	2x	<b>1.447 €</b> •

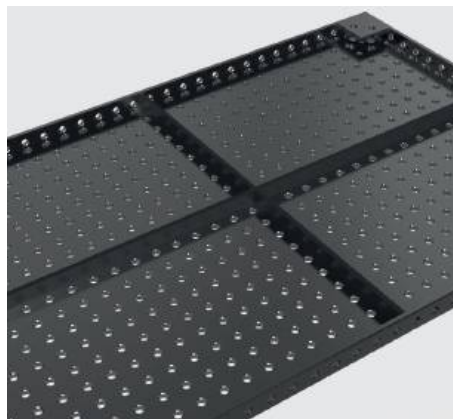



# Professional 750

- Acier de qualité S355J2+N, nitruré plasma et revêtu BAR
- Épaisseur env. 11,5 – 13 mm
- Alésages Ø 16 mm, Alésages sur le dessus de la table quadrillage 50x50 mm
- Hauteur des bandeaux 100 mm, Entraxe alésages bandeau 25 mm
- y compris pieds standards



Dimensions de table	Pieds	Poids			Transport / Emballage
1200 x 1200 mm	4	261 kg	<b>2.029 €</b>	4-160015.P	• 295 €
1500 x 1000 mm	4	281 kg	<b>2.151 €</b>	4-160035.P	• 320 €
2000 x 1000 mm	4	354 kg	<b>2.869 €</b>	4-160020.P	• 358 €
2400 x 1200 mm	6	503 kg	<b>3.931 €</b>	4-160030.P	• 435 €
3000 x 1500 mm	6	758 kg	<b>5.172 €</b>	4-160040.P	• 515 €

Poids = Table + Palette + Pied standard  
 Charge statique totale conseillée pour 4 pieds 2000 kg avec une répartition uniforme de la charge. (Données pour pied standard)



[www.siegmund.com/  
F-table75016](http://www.siegmund.com/F-table75016)

## Pieds de table



	Equipement standard	Equipement standard	Réglable en hauteur	Sur roulette avec frein de blocage	Sur roulette réglable en hauteur avec frein de blocage	Ancre au sol
	160858.X	160857.X	4-160877.XX	4-160876.XX	4-160879.XX	4-160875.XX
Charge par pied	1000 kg	1000 kg	1000 kg	200 kg	200 kg	1000 kg
Hauteur des pieds	750 mm	850 mm	550 – 950 mm	750 mm	600 – 900 mm	750 mm
Réglage fin	40 mm	40 mm	40 mm	30 mm	30 mm	50 mm
Surcoût par pied	inclus	Alternativement	<b>55 €</b>	<b>61 €</b>	<b>92 €</b>	<b>53 €</b>

Hauteur de travail = hauteur du pied + bandeau  
 Les valeurs indiquées se réfèrent à des charges statiques. NB: Les roulettes ne sont pas recommandées pour des tables de soudure à 6 ou 8 pieds.

## Sets



	160610	160630	160645.1.N	160511	160410.N	160420.N	160108.N
<b>1</b>	4-163100	4x		12x		4x	4x
<b>2</b>	4-163200	6x	2x	4x	4x	6x	6x
<b>3</b>	4-163300	8x	4x	4x	4x	8x	8x
<b>4</b>	4-163400	10x	4x	8x	8x	10x	10x
<b>5</b>	4-163500	12x	6x	8x	8x	12x	12x

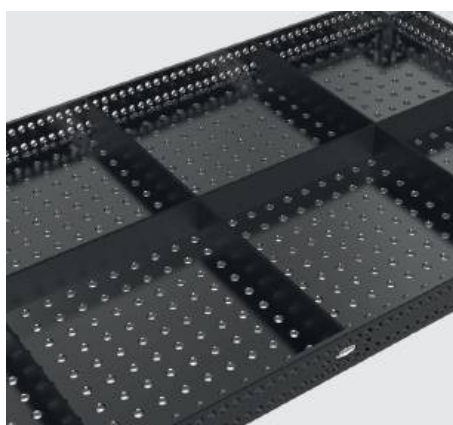
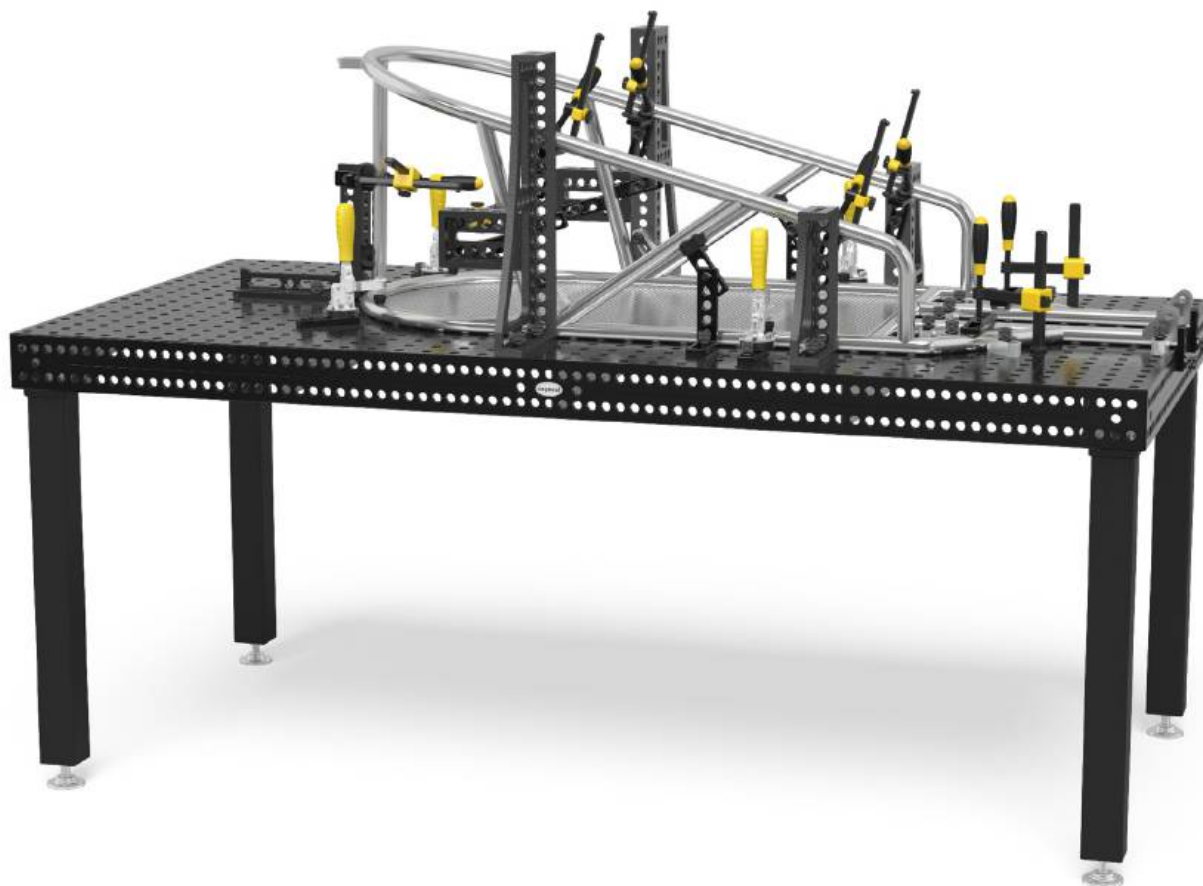

160110.N

4x



160162.N

2x

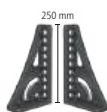

160161+63.N

1x



160134+36.N

1x



160146+48.N

1x



160910

1x



163999

1x

1.067 € •

1.908 € •

2.826 € •

4.293 € •

5.670 € •

# Professional Extreme 8.7

- Acier pour outillage traité à cœur X8.7, nitruré plasma et revêtu BAR
- Épaisseur env. 11,5 – 13 mm
- Alésages Ø 16 mm, Alésages sur le dessus de la table quadrillage 50x50 mm
- Hauteur des bandeaux 100 mm, Alésages sur bandeau de table avec quadrillage diagonal
- Bandeaux en acier de haute qualité S355J2+N
- y compris pieds standards



Dimensions de table	Pieds	Poids		Transport / Emballage
1000 x 500 mm	4	126 kg	<b>1.354 €</b>	4-160005.X7D • 265 €
1000 x 1000 mm	4	192 kg	<b>1.793 €</b>	4-160010.X7D • 275 €
1200 x 800 mm	4	193 kg	<b>1.916 €</b>	4-160025.X7D • 275 €
1200 x 1200 mm	4	259 kg	<b>2.352 €</b>	4-160015.X7D • 295 €
1500 x 1000 mm	4	279 kg	<b>2.474 €</b>	4-160035.X7D • 320 €
1500 x 1500 mm	4	394 kg	<b>3.294 €</b>	4-160050.X7D • 377 €
2000 x 1000 mm	4	351 kg	<b>3.244 €</b>	4-160020.X7D • 358 €
2000 x 1200 mm	4	412 kg	<b>3.897 €</b>	4-160060.X7D • 384 €
2400 x 1200 mm	6	499 kg	<b>4.569 €</b>	4-160030.X7D • 435 €
3000 x 1500 mm	6	753 kg	<b>5.702 €</b>	4-160040.X7D • 515 €
4000 x 2000 mm	8	1255 kg	<b>9.382 €</b>	4-160055.X7D • 813 €



www.siegmund.com/  
F-tableX716

Poids = Table + Palette + Pied standard  
Charge statique totale conseillée pour 4 pieds 2000 kg avec une répartition uniforme de la charge. (Données pour pied standard)  
Toutes nos tables sont disponibles sur commande sans nitruration plasma: www.siegmund.com/F-tableX716

## Pieds de table



	Equipement standard	Equipement standard	Réglable en hauteur	Sur roulette avec frein de blocage	Sur roulette réglable en hauteur avec frein de blocage	Ancre au sol
	160858.X	160857.X	4-160877.XX	4-160876.XX	4-160879.XX	4-160875.XX
Charge par pied	1000 kg	1000 kg	1000 kg	200 kg	200 kg	1000 kg
Hauteur des pieds	750 mm	850 mm	550 – 950 mm	750 mm	600 – 900 mm	750 mm
Réglage fin	40 mm	40 mm	40 mm	30 mm	30 mm	50 mm
Surcoût par pied	inclus	Alternativement	<b>55 €</b>	<b>61 €</b>	<b>92 €</b>	<b>53 €</b>

Hauteur de travail = hauteur du pied + bandeau  
Les valeurs indiquées se réfèrent à des charges statiques. NB: Les roulettes ne sont pas recommandées pour les tables à 6 ou 8 pieds, ainsi que pour les tables 1000 x 500 mm et 1200 x 800 mm à cause du risque de basculement.

## Sets



	160610	160630	160645.1.N	160511	160410.N	160420.N	160108.N
<b>1</b>	4-163100	4x		12x		4x	4x
<b>2</b>	4-163200	6x	2x	4x	18x	4x	6x
<b>3</b>	4-163300	8x	4x	4x	24x	4x	8x
<b>4</b>	4-163400	10x	4x	8x	30x	8x	10x
<b>5</b>	4-163500	12x	6x	8x	36x	8x	12x

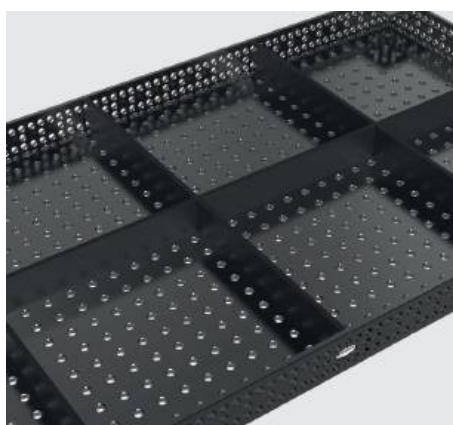

160110.N

4x



160162.N

6x

2x

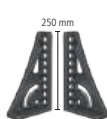

160161+63.N

8x

2x

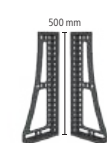

160134+36.N

10x

1x



160146+48.N

12x

1x

1x

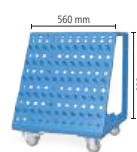

160910

1x



163999

1x

1.067 € •

1.908 € •

2.826 € •

4.293 € •

5.670 € •

# Professional Extreme 8.7 PLUS

- Acier pour outillage traité à cœur X8.7, nitruré plasma et revêtu BAR
- Épaisseur env. 11,5 – 13 mm
- Alésages Ø 16 mm, Alésages sur le dessus de la table quadrillage 50x50 mm
- Hauteur des bandeaux 150 mm, Alésages sur les bandeaux sur 3 lignes entraxe 25 mm, 2 lignes entraxe 50 mm
- Bandeaux en acier de haute qualité S355J2+N
- y compris pieds standards



Dimensions de table	Pieds	Poids		Transport / Emballage
1200 x 1200 mm	4	287 kg	<b>2.612 €</b>	4-160015.X7PL ● 295 €
1500 x 1000 mm	4	313 kg	<b>2.721 €</b>	4-160035.X7PL ● 320 €
2000 x 1000 mm	4	397 kg	<b>3.611 €</b>	4-160020.X7PL ● 358 €
2400 x 1200 mm	6	553 kg	<b>5.075 €</b>	4-160030.X7PL ● 435 €
3000 x 1500 mm	6	850 kg	<b>6.297 €</b>	4-160040.X7PL ● 515 €
4000 x 2000 mm	8	1457 kg	<b>10.372 €</b>	4-160055.X7PL ● 813 €



Poids = Table + Palette + Pied standard  
 Charge statique totale conseillée pour 4 pieds 2000 kg avec une répartition uniforme de la charge. (Données pour pied standard)  
 Toutes nos tables sont disponibles sur commande sans nitruration plasma: [www.siegmund.com/F-tableX716plus](http://www.siegmund.com/F-tableX716plus)



[www.siegmund.com/F-tableX716plus](http://www.siegmund.com/F-tableX716plus)

## Pieds de table



	Equipement standard	Equipement standard	Réglable en hauteur	Sur roulette avec frein de blocage	Sur roulette réglable en hauteur avec frein de blocage	Ancre au sol
	160853.X	160857.X	4-160877.XX	4-160860.XX	4-160879.XX	4-160872.XX
Charge par pied	1000 kg	1000 kg	1000 kg	200 kg	200 kg	1000 kg
Hauteur des pieds	700 mm	850 mm	550 – 950 mm	700 mm	600 – 900 mm	700 mm
Réglage fin	40 mm	40 mm	40 mm	30 mm	30 mm	50 mm
Surcoût par pied	inclus	Alternativement	<b>55 €</b>	<b>60 €</b>	<b>92 €</b>	<b>53 €</b>

Hauteur de travail = hauteur du pied + bandeau  
 Les valeurs indiquées se réfèrent à des charges statiques. NB: Les roulettes ne sont pas recommandées pour des tables de soudure à 6 ou 8 pieds.

## Sets



	160610	160630	160645.1.N	160511	160410.N	160420.N	160108.N
<b>1</b>	4-163100	4x		12x		4x	4x
<b>2</b>	4-163200	6x	2x	4x	18x	4x	6x
<b>3</b>	4-163300	8x	4x	4x	24x	4x	8x
<b>4</b>	4-163400	10x	4x	8x	30x	8x	10x
<b>5</b>	4-163500	12x	6x	8x	36x	8x	12x



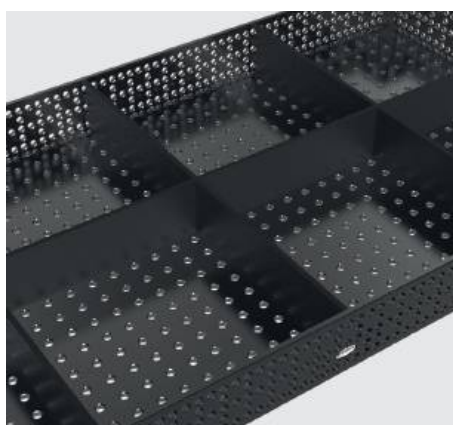
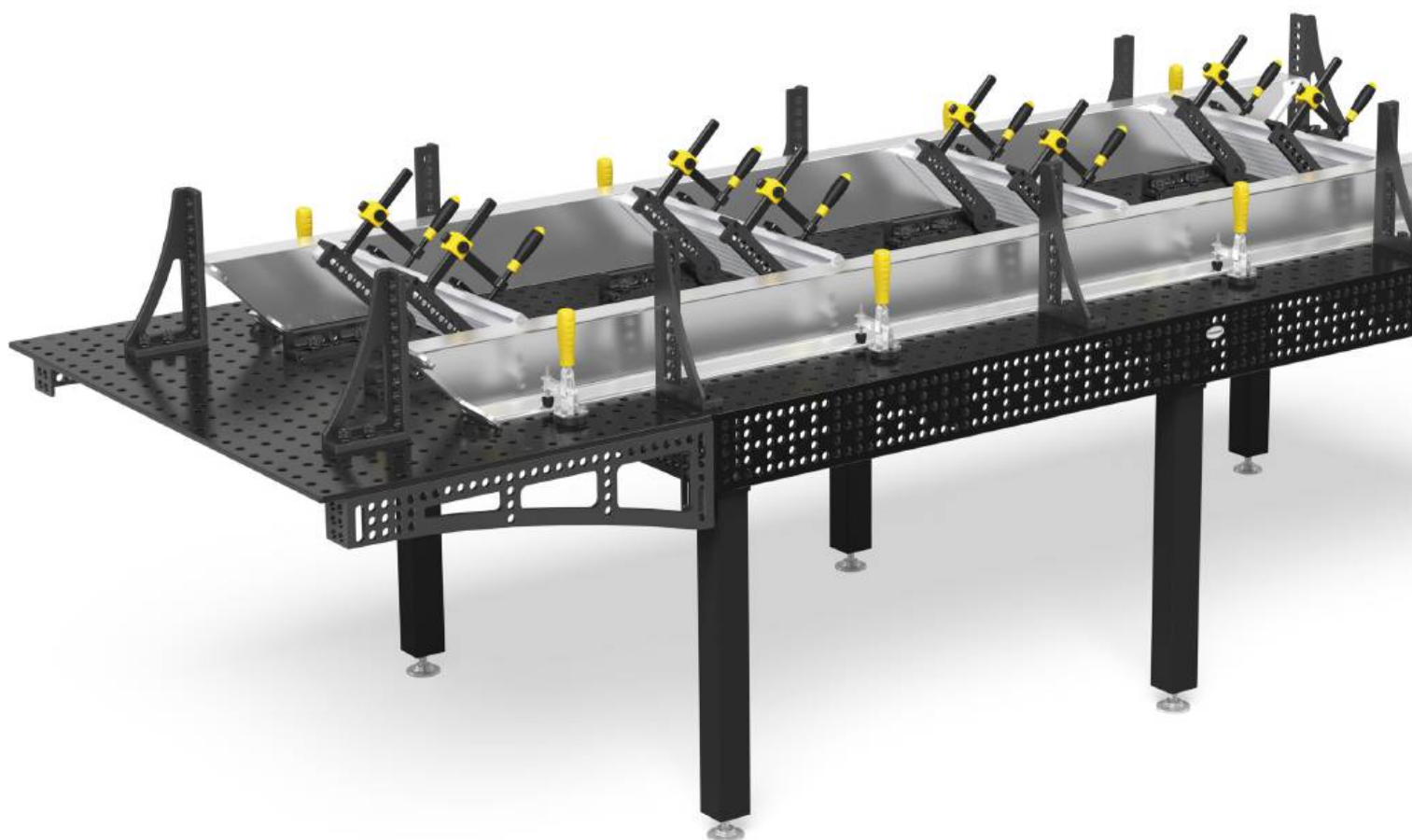

160110.N

4x



160162.N

2x

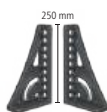

160161+63.N

1x



160134+36.N

1x



160146+48.N

1x

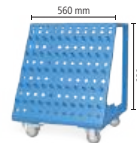

160910

1x



163999

1x

1.067 € •

1.908 € •

2.826 € •

4.293 € •

5.670 € •



# PROMOS EXCLUSIVES

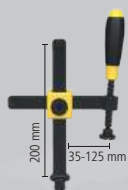
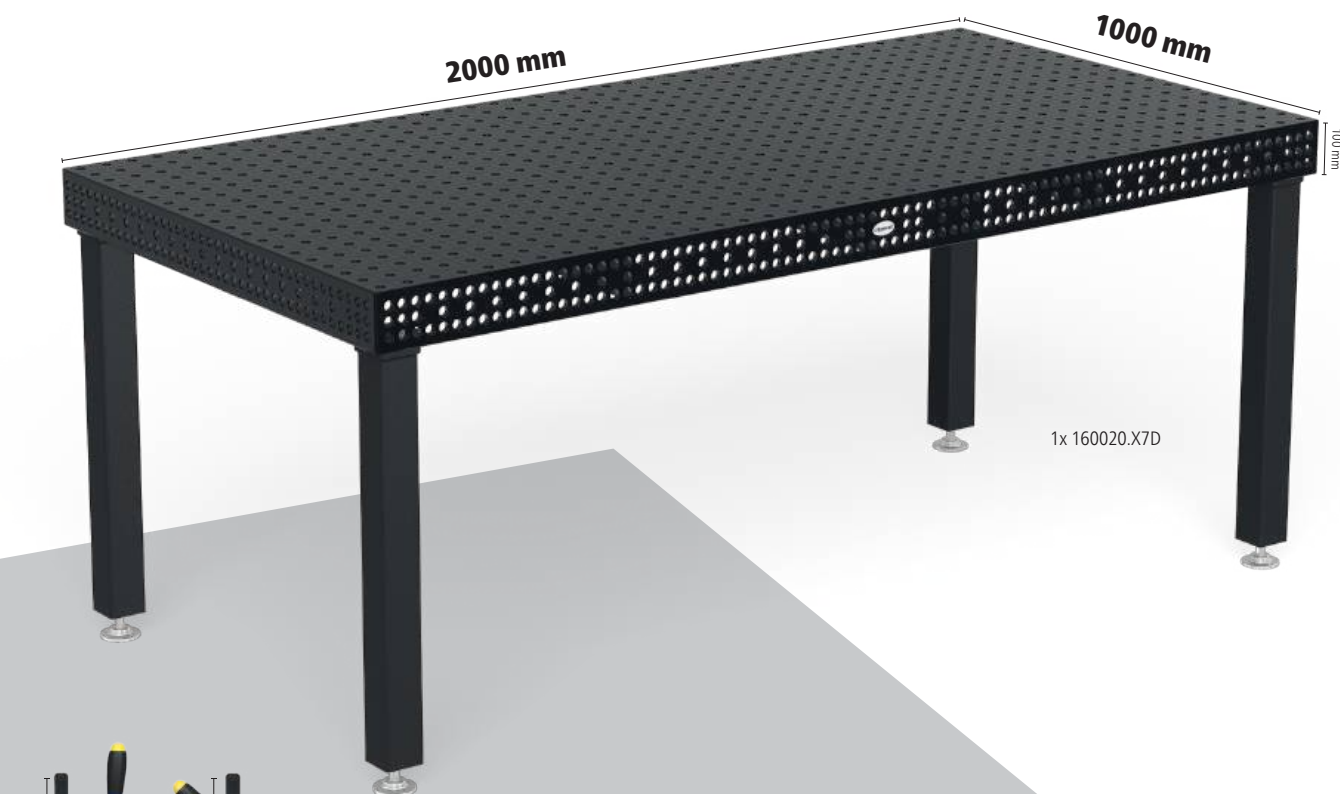

4x 160610



2x 160630



12x 160511



4x 160410.N



6x 160420.N



6x 160108.N



4x 160110.N



2x 160162.N



4x 160645.1.N

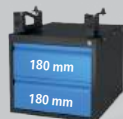

1x 160990.1



FOR FREE 1x 163999



## Table de soudure et de bridage Extreme 8.7

### Accessoires compris

- Acier pour outillage traité à cœur X8.7 + Nitruration plasma
- Bandeaux en acier de haute qualité S355J2+N + Nitruration plasma
- Alésages Ø 16 mm
- Alésages sur le dessus de la table quadrillage 50x50 mm
- Épaisseur env. 11,5 – 13 mm
- Hauteur des bandeaux 100 mm
- Alésages sur bandeau de table avec quadrillage diagonal
- Coins, bords et alésage System arrondis
- Graduation comprise sur le dessus de la table
- Châssis renforcé par des traverses

Prix Promo %

**5.353 €**

au lieu de 5.756 €

4-168120.X7D

Emballage / Transport 358 €



## Table de soudure et de bridage Professional 750

### Accessoires compris

- Acier de qualité S355J2+N + Nitruration plasma
- Alésages Ø 16 mm
- Alésages sur le dessus de la table quadrillage 50x50 mm
- Épaisseur env. 11,5 – 13 mm
- Hauteur des bandeaux 100 mm
- Entraxe alésages bandeau 25 mm
- Coins, bords et alésage System arrondis
- Graduation comprise sur le dessus de la table
- Châssis renforcé par des traverses

Prix Promo **0%**

**3.713 €**

au lieu de 3.993 €

4-168435.P

Emballage / Transport 320 €

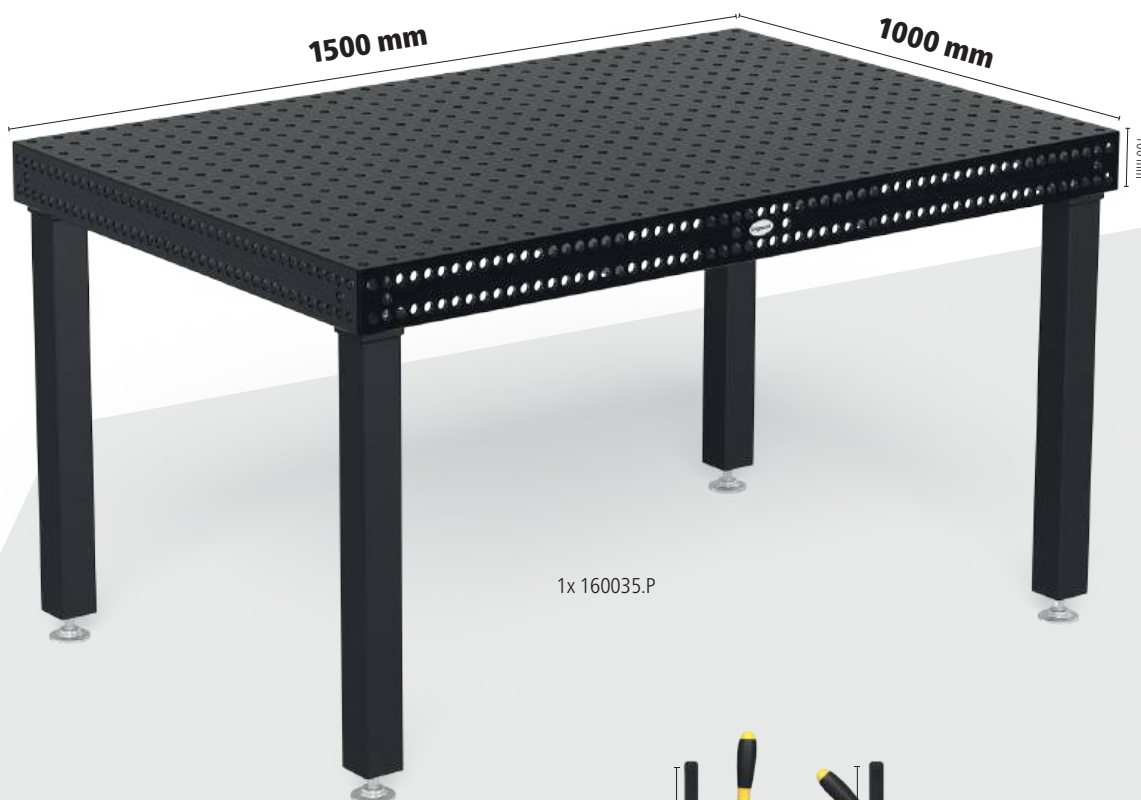

1x 160035.P



4x 160610



2x 160630



12x 160511



6x 160108.N



4x 160110.N



4x 160410.N



6x 160420.N



4x 160645.1.N



FOR FREE 1x 163999

# siegmund



**Notre planning salons,  
voir plus bas:**

[www.siegmund.com/F-exhibition](http://www.siegmund.com/F-exhibition)



**Fabricant:**

**Bernd Siegmund GmbH**

Landsberger Str. 180  
86507 Oberottmarshausen  
Allemagne (Bavière)  
Tél. +49 (0) 8203 96 07-0  
[info@siegmund.com](mailto:info@siegmund.com)  
[siegmund.com](http://siegmund.com)

**Vos correspondants:**

**WELDA.be**  
SOUDAGE | MACHINES | OUTILLAGE

Antwerpsesteenweg 949, 9041 Oostakker-Gand  
+32 (0) 9 355 74 26 • [INFO@WELDA.BE](mailto:INFO@WELDA.BE)

[WWW.WELDA.BE](http://WWW.WELDA.BE)

Lundi à vendredi  
8h-12h et 13h-18h